

**SUPER 286
BABY MAINBOARD
12 MHz ZERO WAIT**

TABLE OF CONTENTS

<i>Specifications</i>	1
<i>How to Set up Your 286 Motherboard</i>	2
<i>Installation</i>	13
<i>EMS Driver Set-up</i>	15
<i>EMS Driver Preparation</i>	17
<i>Connector Pinouts</i>	21
<i>I/O Channels</i>	25
<i>System Block Diagram</i>	27
<i>Memory Address Range</i>	28

IBM PC™, PC/XT™, PC/AT™ are registered trademarks of International Business Machines Corp.

SPECIFICATIONS

- * 6 or 12 MHz 80286 selectable by keyboard or by hardware switch, 80286-12 CPU.
- * 4MB high-speed memory standard
- * 16MB expandable in the protected virtual address mode
- * 2 sockets for PHOENIX, AWARD, ERSO or AMI BIOS (any BIOS fully compatible with IBM™ BIOS)
- * 8 I/O expansion slots
- * Socket for 80287 numeric processor
- * CMOS clock and calendar circuit
- * Battery on-board (easily serviced, easily replaced)
- * 6 custom chips set used to reduce total ICs
- * EMS control circuit
- * 24-bit addressing and 16-bit data pathing capabilities
- * 16-level interrupt
- * 7-channel direct memory access (DMA)
- * 3-programmable timers
- * Speaker/keyboard connector
- * Standard AT™ power supply connector
- * Small AT™ dimensions
- * High temperature burned-in
- * 0-wait state or 1-wait state selectable

How to Set Up Your 286 Motherboard

A. BIOS ROM

1. BIOS ROM (Lo) is inserted into ROM1.
2. BIOS ROM (Hi) is inserted into ROM2.

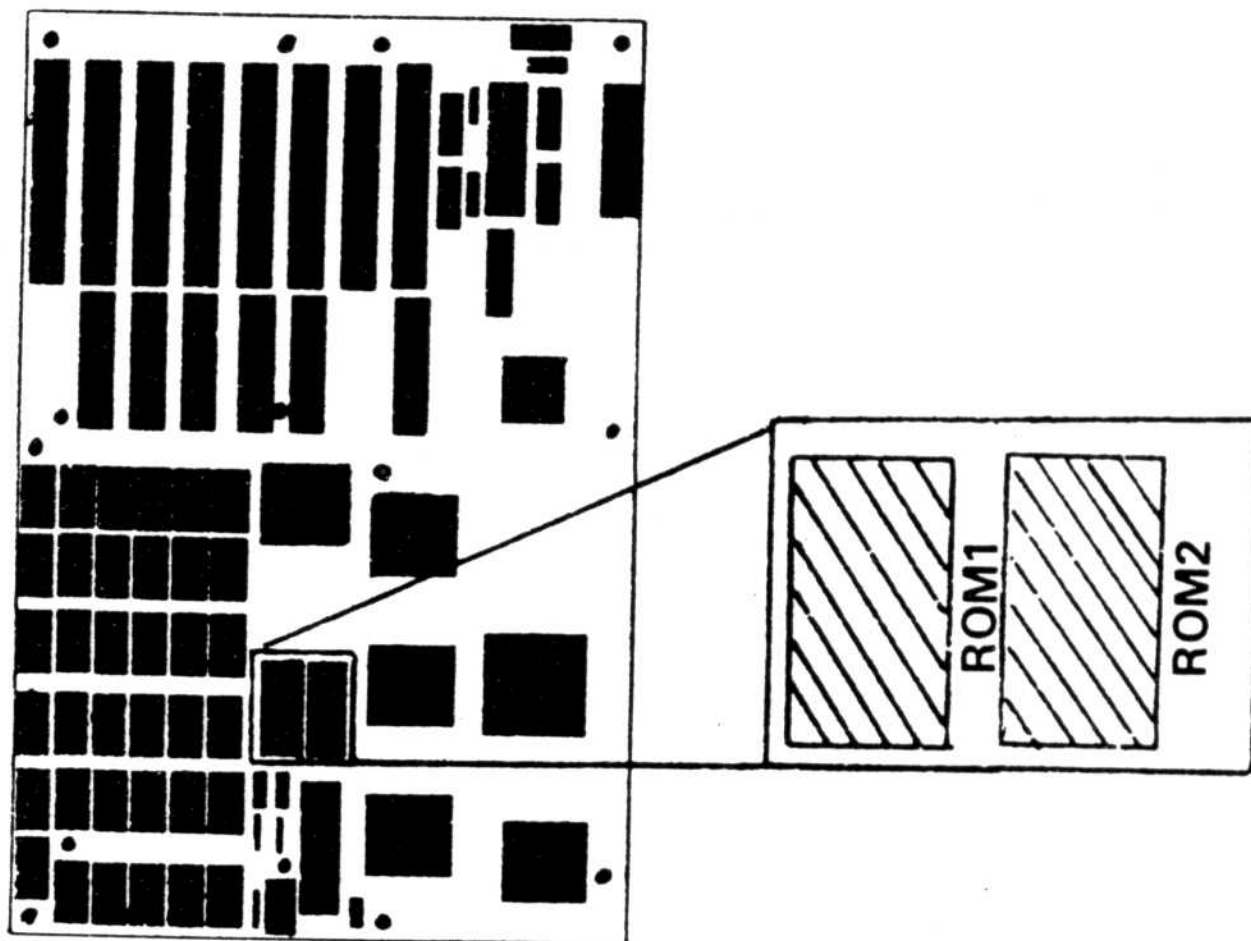

Figure 1

3. When ROM type 27128 is used,
DIP switch -5 is set to ON.
4. When ROM type 27256 is used,
DIP switch -5 is set to OFF

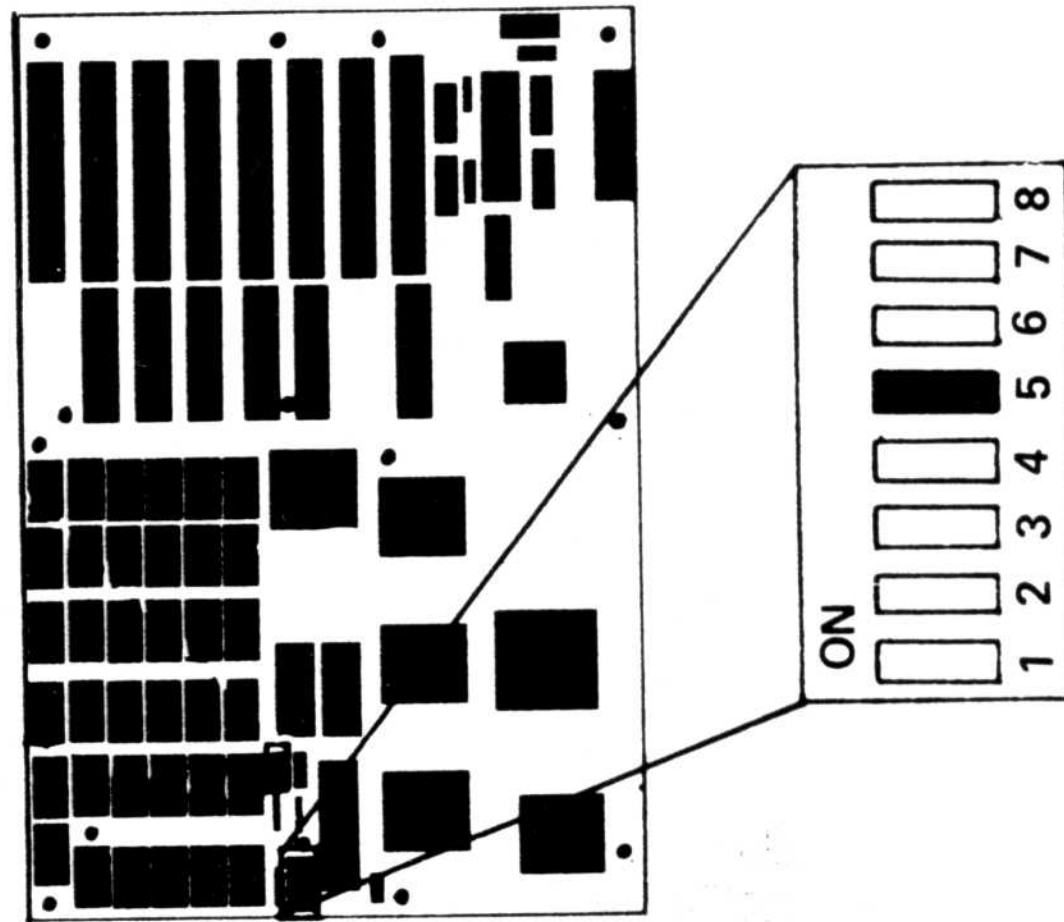

Figure 2

B. KEYBOARD BIOS

1. 8742 with keyboard BIOS programmed in it is inserted into the location marked "8742".

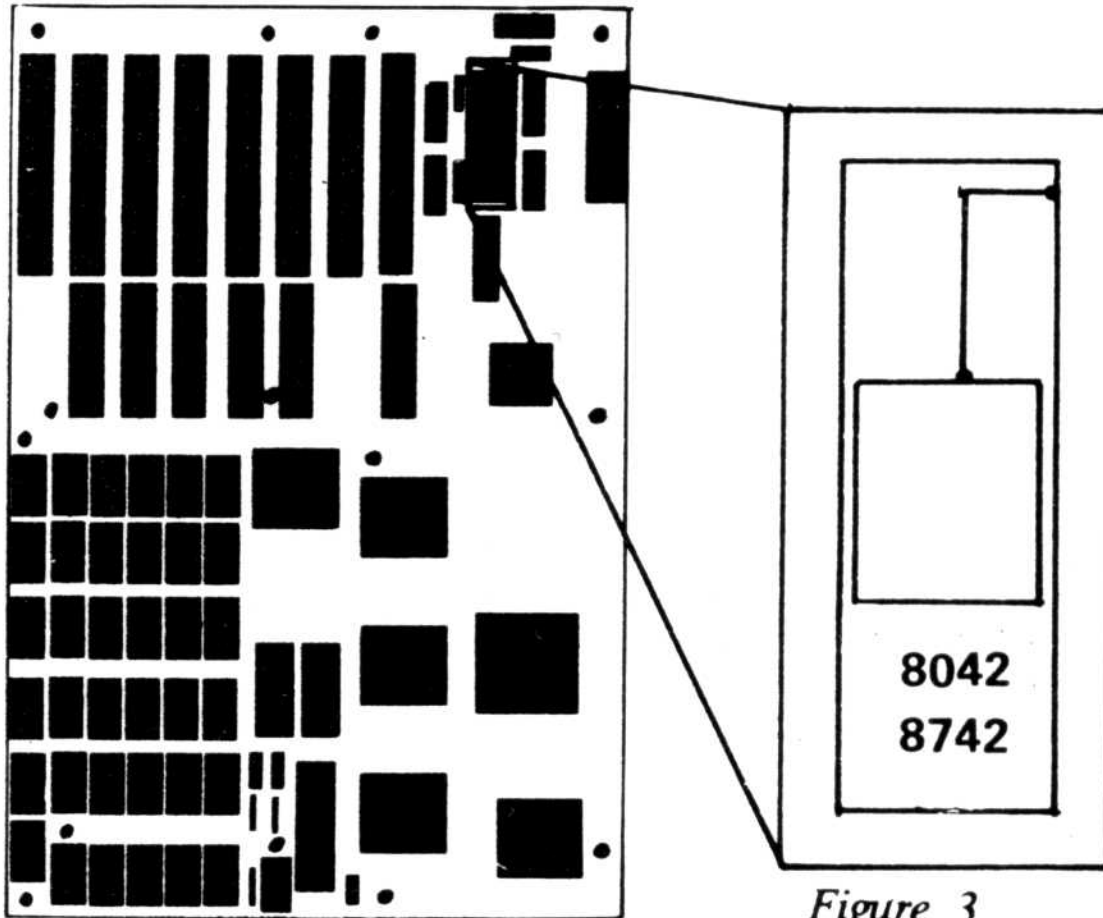

Figure 3

2. When an AWARD type keyboard BIOS (switchable by using port 22) is used, JP3 is set to CLOSE,
3. When a PHOENIX type keyboard BIOS (switchable by using Port 15) is used, JP1 is set to CLOSE

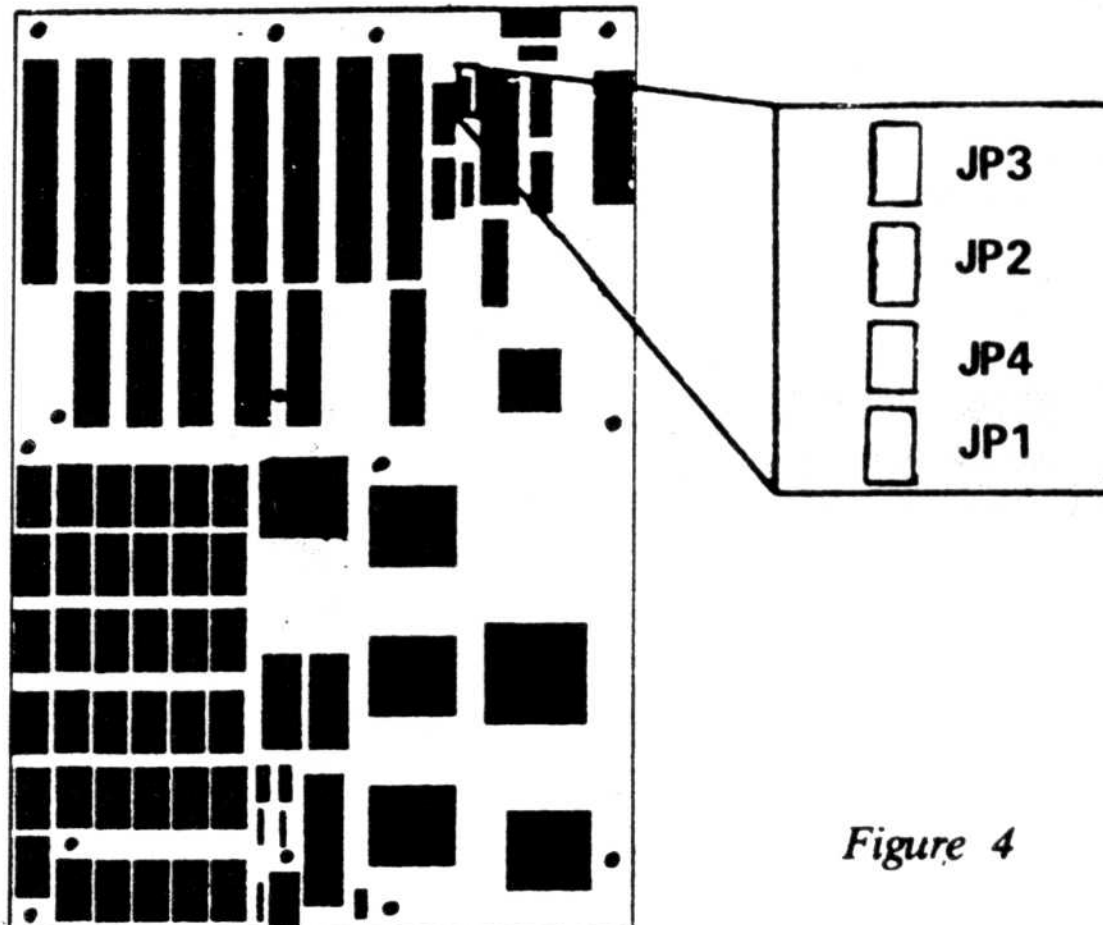

Figure 4

C. DRAM

1. A total of 8 (0-7) modes are available depending on memory sizes, for insertion of DRAMs. The figures below show the methods of DRAM insertion. When 4164 or 41256 DRAM is used, the DRAM is inserted into the 16-pin side. When 421000 DRAM is used, it is inserted into the 18-pin side.

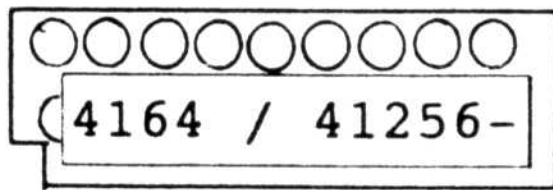

Figure 5

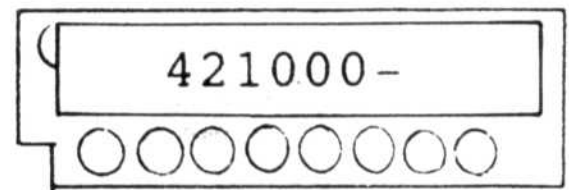

Figure 6

MODE SETTINGS

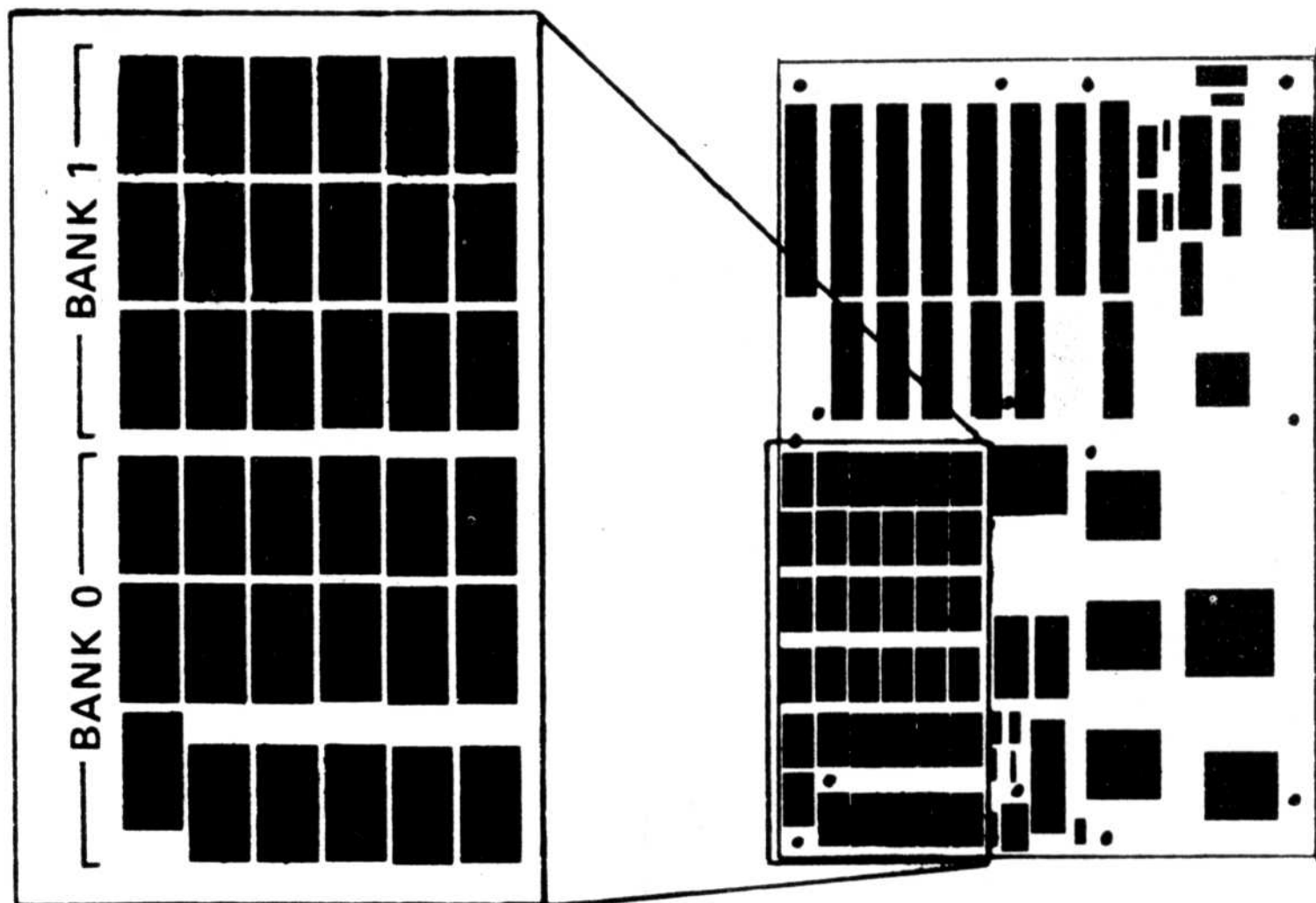

Figure 7

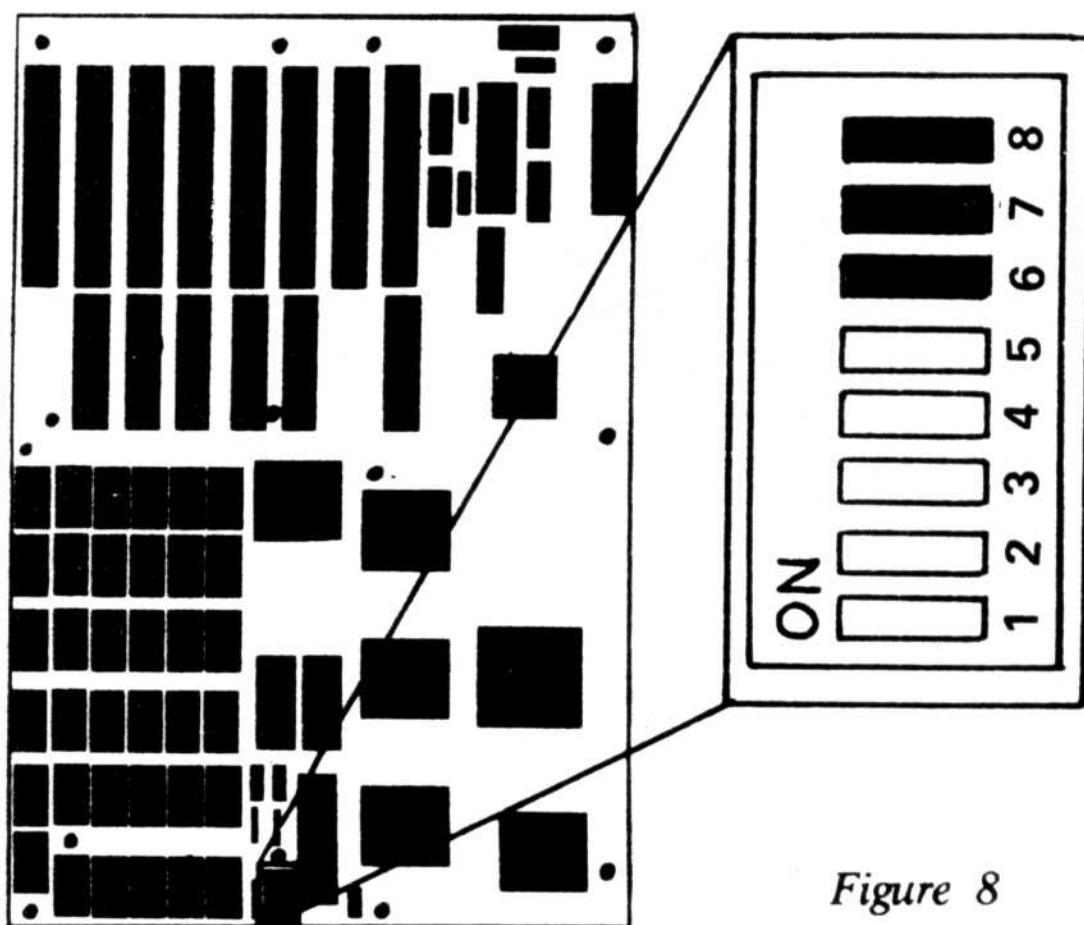

Figure 8

2. MODE 0

A total of 18 DRAMs(41256-8)are inserted onto BANK0. The DIP switches -6, -7, -8 are each set to ON. In MODE 0, the memory location is 00000 - 7FFFFH and the memory size is 512KB.

3. MODE 1

A total of 18 DRAMs(41256-8)are inserted onto BANK 0, and a total of 18 DRAMs (4164-8) are inserted onto BANK 1. The DIP switches -6, -7, and -8 are set to ON, ON, and OFF respectively. In MODE 1, the memory location is 00000 - 9FFFFH and the system memory size is 640KB.

4. MODE 2

A total of 18 DRAMs(41256-8)are inserted onto BANK 0, and a total of 18 DRAMs(41256-8) are inserted onto BANK 1. The DIP switches -6, -7, and -8 are set to ON, OFF and ON respectively. In MODE 2, the memory locations are 00000 - 9FFFFH and 100000H - 15FFFFH. System memory size is 640KB and expansion memory size is 384KB.

5. MODE 3

A total of 18 DRAMs(41256-8)are inserted onto BANK 0 and a total of 18 DRAMs(41256-8) are inserted onto BANK 1. The DIP switches -6, -7, and -8 are set to ON, OFF and OFF respectively. In MODE 3, the memory location is 00000 - 9FFFFH and the system memory size is 640KB + EMS (384KB). The EMS (384KB) memory can be used as an EXPAND memory with a capacity of 16KB x 24 pages, by using a SUNTAC EMS driver program.

6. MODE 4

A total of 18 DRAMs(421000-8)are inserted into BANK 0. The DIP switches -6, -7, and -8 are set to OFF, ON and ON respectively. In MODE 4, the memory locations are 00000 - 9FFFFH and 100000H - 25FFFFH and the system memory size is 640KB + 1,408KB.

7. MODE 5

A total of 18 DRAMs(421000-8)are inserted onto BANK 0. The DIP switches -6, -7 and -8 are set to OFF, ON, and OFF respectively. In MODE 5, the memory location is 00000 - 9FFFFH; the system memory size is 640KB + EMS (1,408KB). The EMS (1,408KB) memory can be used as an EXPAND memory with a capacity of 16KB x 88 pages, by using a SUNTAC EMS driver program.

8. MODE 6

A total of 18 DRAMs(421000-8) are inserted onto BANK 0 and a total of 18 DRAMs (421000-8) are inserted onto BANK 1. The DIP switches -6, -7 and -8 are set to OFF, OFF and ON respectively. In MODE 6, the memory locations are 00000 - 9FFFFH and 100000H - 45FFFFH; the system memory size is 640KB + 3,456KB.

9. MODE 7

A total of 18 DRAMs(421000-8)are inserted onto BANK 0 and a total of 18 DRAMs(421000-8) are inserted onto BANK 1. The DIP switches -6, -7 and -8 are set to OFF, OFF and OFF respectively. In MODE 7, the memory location is 00000 - 9FFFFH and the system memory size is 640KB + EMS (3,456KB). The EMS (3,456KB) memory can be used as an EXPAND memory with a capacity of 16KB x 216 pages, by using a SUNTAC EMS driver program.

D. MONITOR TYPE

1. When a color monitor is used, DIP switch -2 is set to ON.
2. When a monochrome monitor is used, DIP switch -2 is set to OFF.

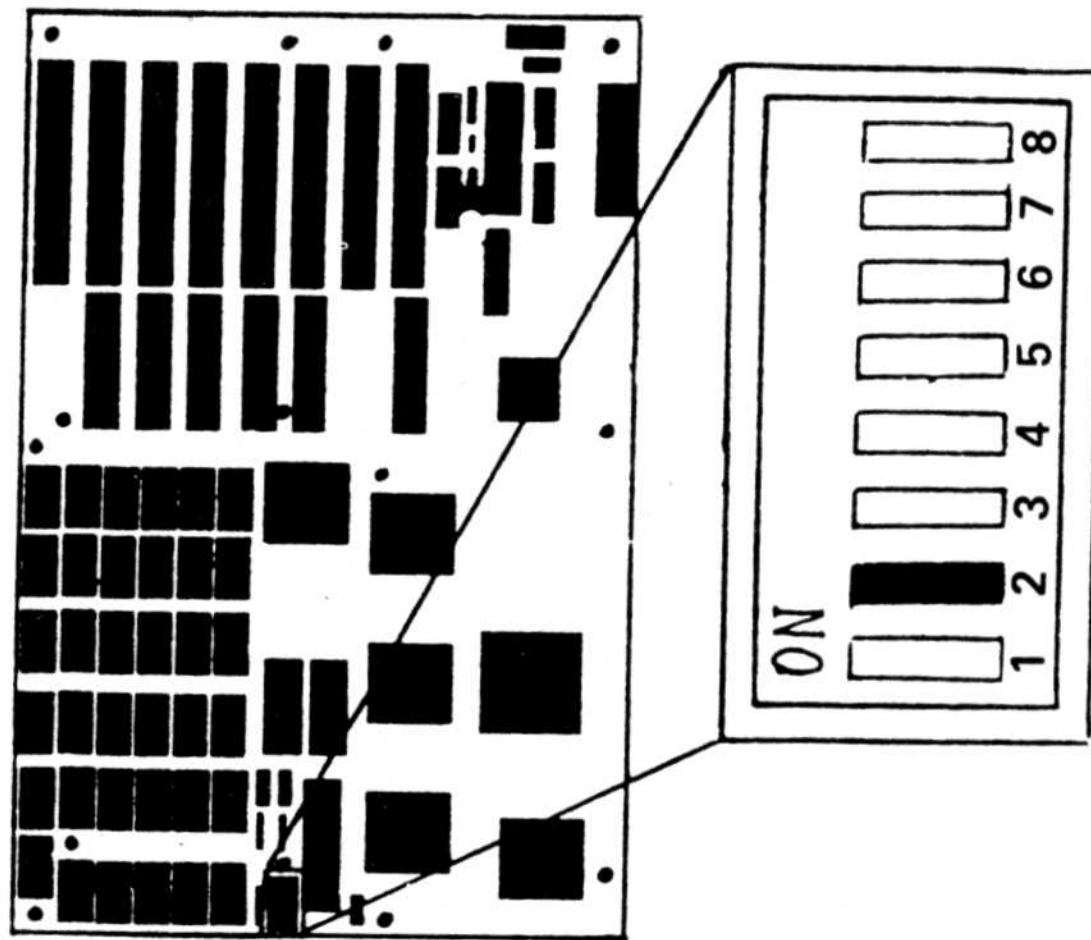

Figure 9

E. CLOCK SPEED SWITCHING

1. When switching speeds externally:
A mechanical switch is installed onto JP7,
JP7 in the OPEN state provides Low speed,
when CLOSED, it provides High speed.
2. When JP7 is OPEN, the clock speed can be
switched by using the keyboard. When using
AWARD BIOS, keys **CTRL**, **ALT** and **-**
(minus) are pressed simultaneously to switch to
High speed. Keys **CTRL**, **ALT** and **+** (plus)
are pressed simultaneously to switch to Low speed.
3. If the power is turned on while JP7 is OPEN, it
will turn to Low speed. If JP7 is CLOSED; it
will invalidate the keyboard operation and will
switch to High speed at all times.
4. When using PHOENIX BIOS, keys **CTRL** **ALT**
and **** are pressed simultaneously to switch
speeds.

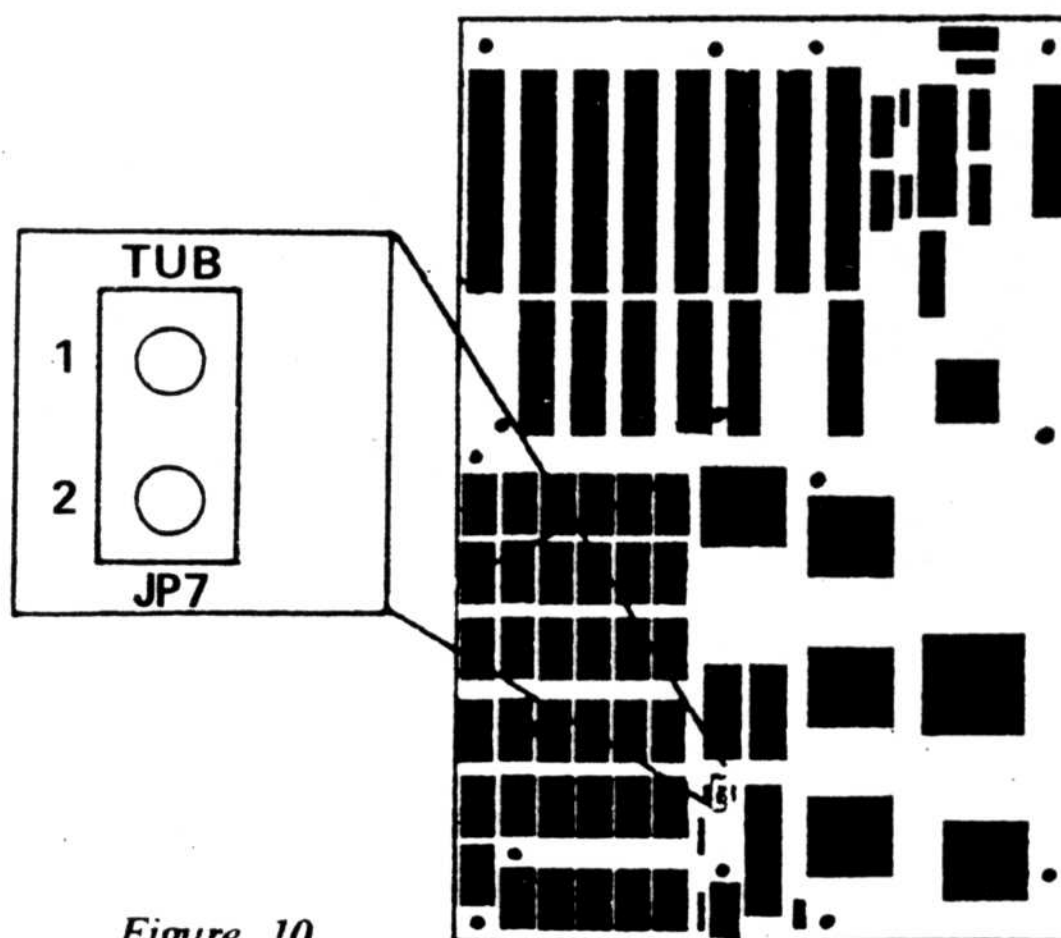

Figure 10

F. EMS PORT ADDRESS

1. When using 098 - 09FH as the EMS Port Address, DIP switch -4 is set to OFF. The SUNTAC EMS driver program setting is used at this point.
2. When using 0E8 - 0EFH as the EMS Port Address, DIP switch -4 is set to ON. The SUNTAC EMS driver program setting is used at this point.

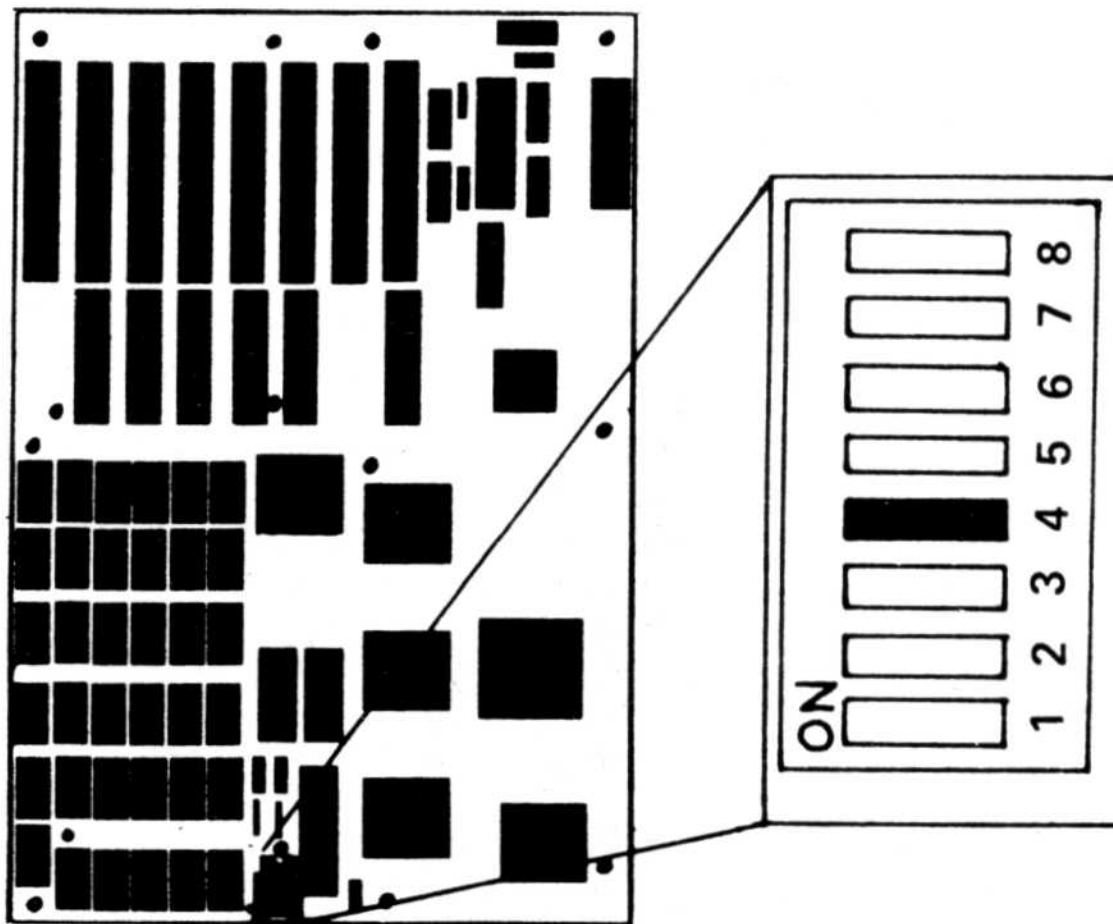

Figure 11

G. RESET SWITCH

A mechanical switch is installed onto JP6. When JP6 is OPEN, the CPU will run; when JP6 is CLOSED, the CPU will be reset.

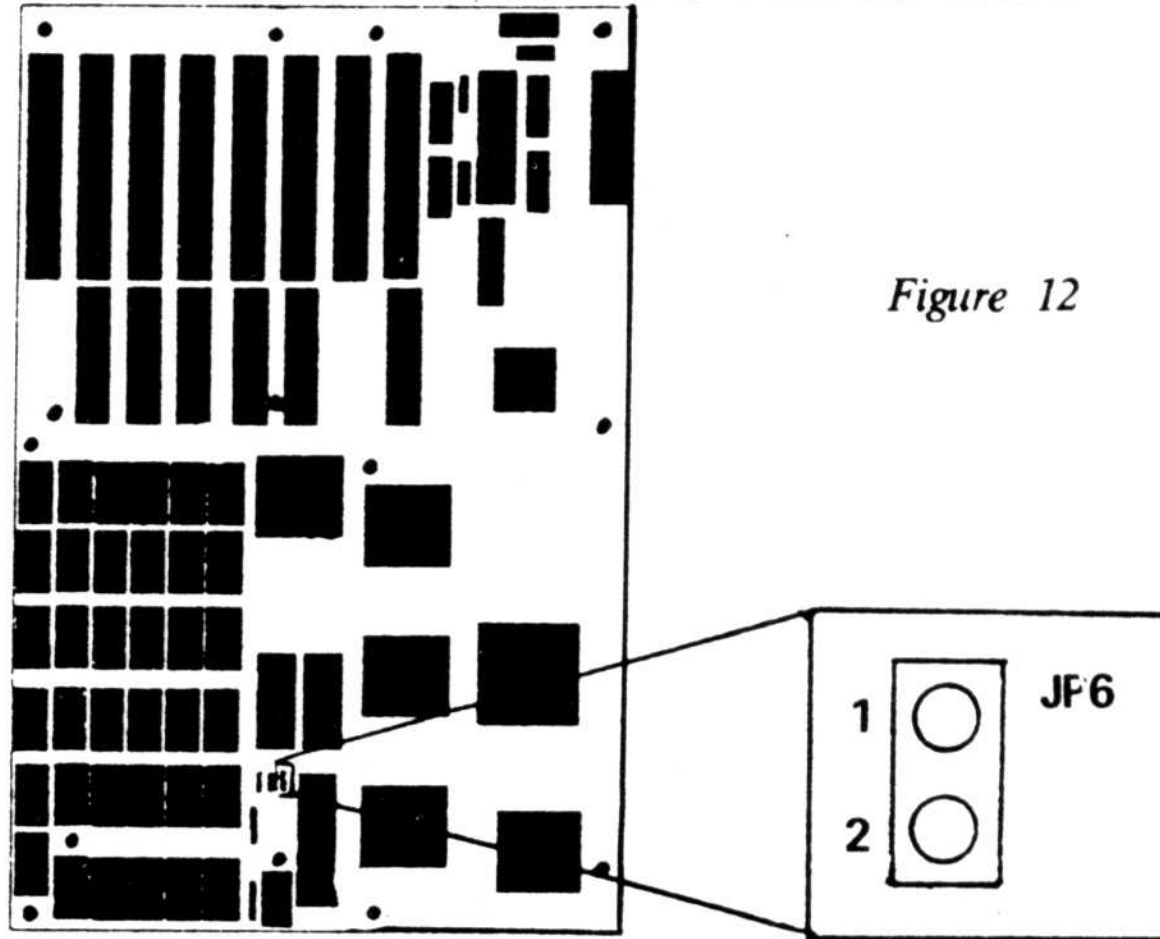

Figure 12

H. MAIN MEMORY WAIT STATE SELECTION

A mechanical switch is installed onto JP5. When JP5 is OPEN, the setting will be one wait state. When JP5 is CLOSED, the setting will be zero wait state.

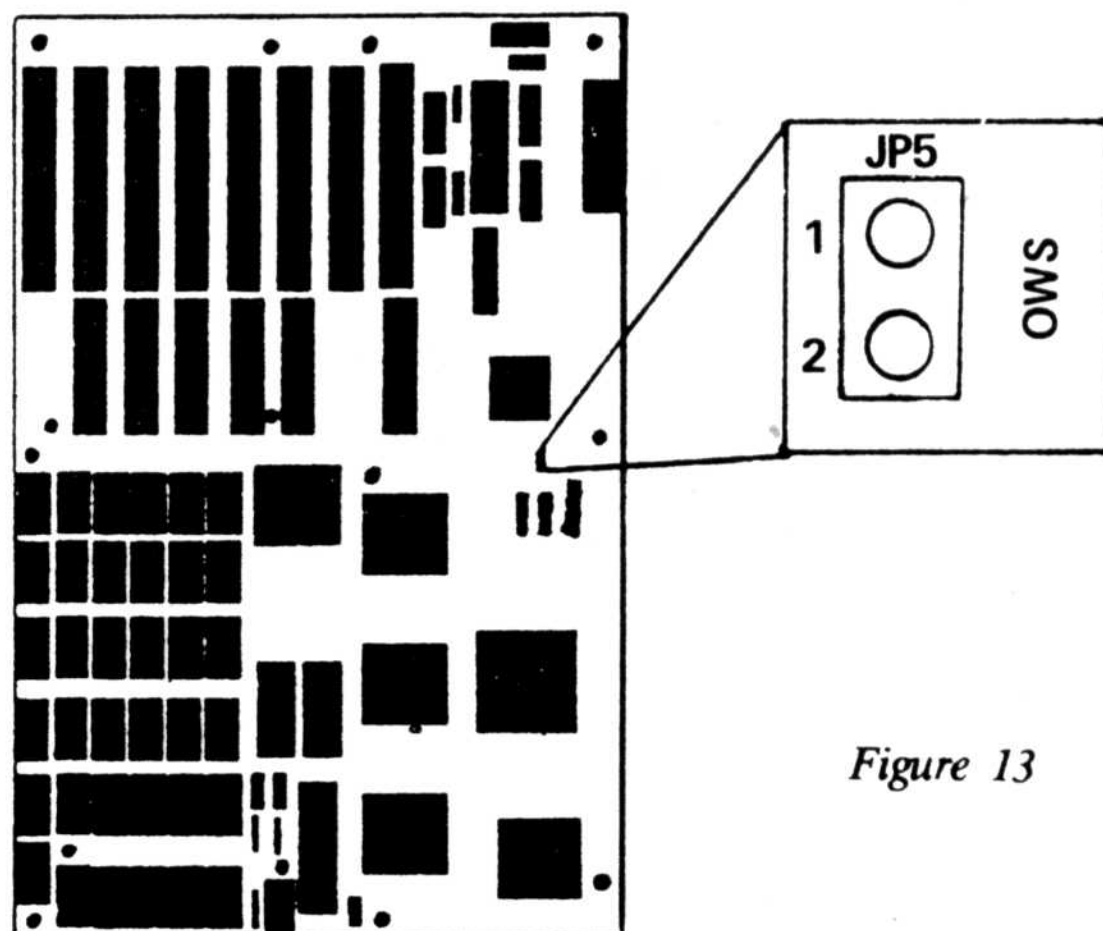

Figure 13

INSTALLATION

Peripherals required:

- 1) 286 Motherboard
- 2) IBMAT™ power supply or compatible equivalent
- 3) IBM™ monochrome/graphics display board, color card, EGA card or compatible equivalent
- 4) IBM™ keyboard or compatible equivalent
- 5) Monochrome, color, or EGA monitor

Procedures:

- 1) Connect power supply connectors to P8 as marked.
- 2) Plug in keyboard connector to the keyboard receptical (J22) at the back.
- 3) Install monochrome or color graphic display board in expansion slot 1 or 7.
- 4) Select monochrome or color at DIP switch -2.
- 5) Connect monitor cable to the display board.
- 6) Make sure "LOW BYTE" or "EVEN BYTE" BIOS is on IC23.
- 7) Make sure "HIGH BYTE" or "ODD BYTE" BIOS is on IC33.
- 8) Set the RAM size as follows by DSP1: #6-8.

#8	#7	#6	MODE	SIZE
ON	ON	ON	0	512KB
OFF	ON	ON	1	640KB
ON	OFF	ON	2	640KB + 384KB
OFF	OFF	ON	3	640KB + EMS (384KB)
ON	ON	OFF	4	640KB + 1408KB
OFF	ON	OFF	5	640KB + EMS (1048KB)
ON	OFF	OFF	6	640KB + 3456KB
OFF	OFF	OFF	7	640KB + EMS (3456KB)

- 9) For those which have the IBM PC/AT™ chassis or compatible equivalent, plug in the speaker connector to SP, and the "Power LED and EXT LOCK" connector to J20 at the front, and the "TURBO LED" connector to JP8.
- 10) Turn on the monitor.
- 11) Turn on the power supply.

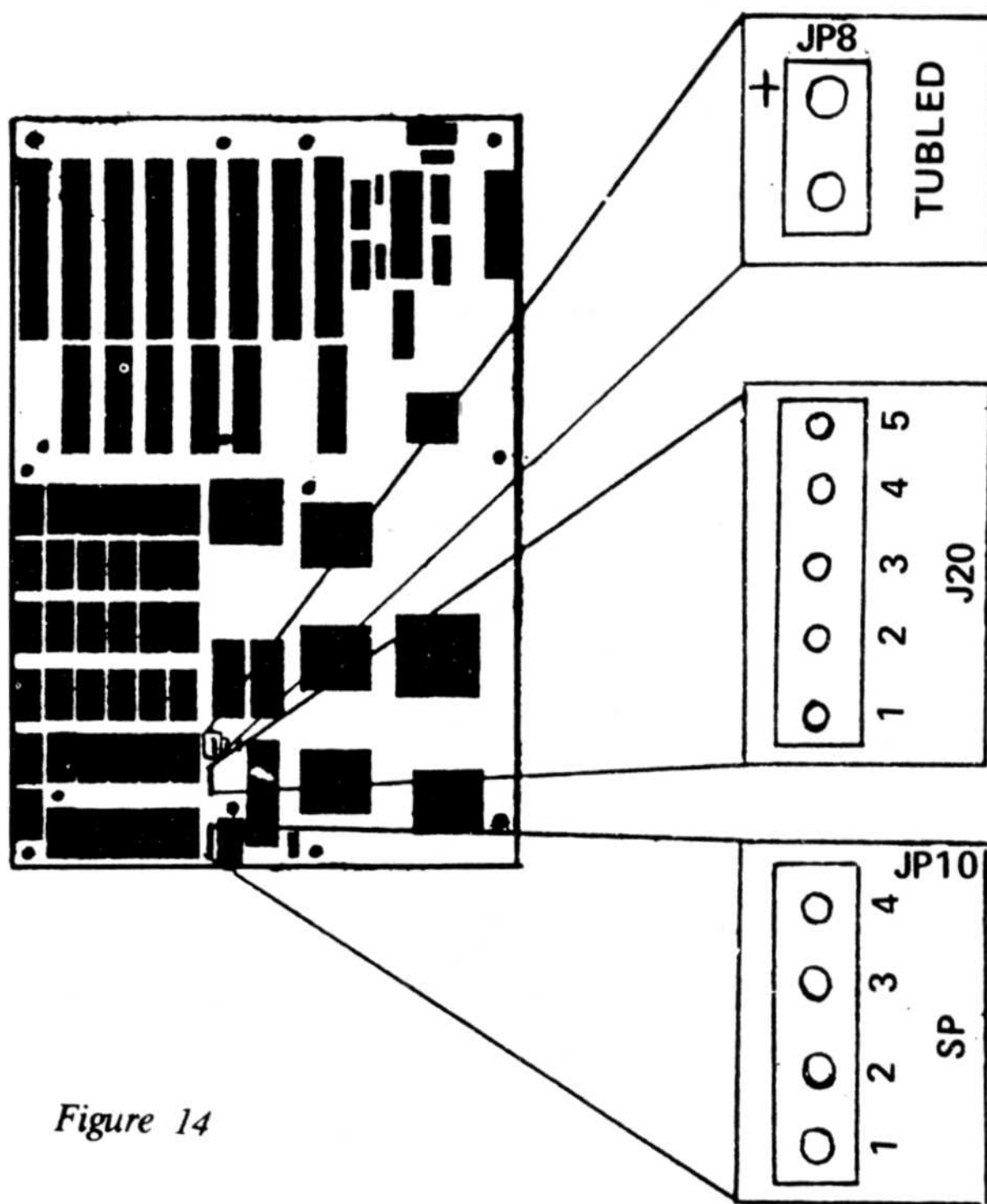

Figure 14

EMS DRIVER SET-UP

1. Boot your PC™ system by using DOS™ and the system will prompt you with A>.
2. Copy the SEMS.SYS file onto your DOS™ diskette.
3. Type:

```
COPY CON CONFIG.SYS <Return>  
DEVICE=SEMS.SYS /M:xxx /P:xxxx /I:xxx <Return>  
^Z <Return>
```

where M:xxx = System memory size, default is 640KB.

P:xxxx = EMS Physical page segment address,
default automatic.

I:xxx = EMS Port address E8H or 98H.

The screen will display as follows:

```
1 File(s) copied
```

```
A>
```

4. Reboot your system. The following screen will appear:

```
*****  
* SUNTAC-62 Chip Set EMS Driver Rev. 1.00 *  
* (C) Copyright SUN ELECTRONICS CORP. 1987*  
*****  
  
EMS DRIVER INSTALL TOTAL PAGES: xxxx  
EMS PAGE SEGMENT: xxxxH  
EMS PORT ADDRESS: xxxxH  
A >
```

5. You can run RAMBANK SOFTWARE like VD.SYS, PB.COM, or RAMTEST.

Example:

If 384K has been set as the virtual disk, type in the command line as follows:

```
COPY CON CONFIG.SYS <Enter>  
DEVICE=SEMS.SYS <Enter>  
DEVICE=VD.SYS /384/ <Enter>  
^Z <Enter>
```

- Note:
1. The EMS software supports SEMS, SEMS4, SEMS5.
 2. If you have VGA & ARCNET in your system, you probably need to set DEVICE-SEMS5.SYS/P:CCOO/.

INSTRUCTION FOR EMS DRIVER PREPARATION

1. After the power is turned on, and before DRAM begins refreshing, an initial value needs to be written into EMS Register R0. (This writing should be done within BIOS ROM.)

Initial values

- (1) Write 9DH when I/O port address is E8H.
 - (2) Write 93H when I/O port address is 98H.
2. When the data has been written into EMS Registers R0-R7, Bit 7 in R0 has to be read in order to confirm whether the Register contents have been transferred from DADR to HADA.
 - (1) When Bit 7 in R0 is 1, the transfer has yet to be achieved.
 - (2) When Bit 7 in R0 is 0, the transfer has been achieved.
 3. The system memory size in the EMS Register should not be set at any value larger than 640KB (A0H).
 4. The segment start address in EMS Register R3 should not be set at any value smaller than the system memory size (R2).

5. When setting the page numbers of banks 0-3 in EMS Registers R4-R7, the numbers should correspond to the page numbers counted, by 16KB units, from the DRAM address 0000 : 000H.

Example:

When EMS has a system memory size of 640KB and the usable page head is to be set:

$$640 - 16 = 40 \text{ (28H)}$$

Therefore, 28H is set as the page head.

Incidentally, a physical page can be released by setting its corresponding bank at 0.

6. The banks 0-3 in EMS Registers R4-R7 are always in correspondence to physical pages 0-3
7. When the system memory size is 1MB (as shown in the Memory Address Setting 3 on page 28) the setting of EMS page No. at 40H will result in the production of an image from the memory's 0000 : 0000H.
8. EMS maximum pages Nos. are 216 pages at 4MB. The memory size that can be used with DOS™ is 640KB.

EMS INTERFACE

EMS Port Address

EMS98/E8	Location	Description
"L"	E8H	Access to 80287 is impossible at E8-EFH.
"H"	98H	Access to 74LS612 is impossible at 98-9FH.

EMS Registers

		D7	D6	D5	D4	D3	D2	D1	D0	Description	
R0	Variable port address.	T/R flag	Variable port address.								T/R flag Read 1: Transfer yet to be done 0: Transfer done Write 1: Read possible 0: Read impossible
	Transfer flag (Read) RO Read enable (Write)		A9	A8	A7	A6	A5	A4	A3		
R1	Reserved										
R2	System memory size.	A19	A18	A17	A16	A15	A14	fixed 0		Read impossible (A0H 00000-9FFFFH)	
R3	Segment start address.	A19	A18	A17	A16	A15	A14	fixed 0		Read impossible (C0H:segmentC000H)	
R4	Bank 0	P7	P6	P5	P4	P3	P2	P1	P0	Read impossible	
R5	Bank 1	P17	P16	P15	P14	P13	P12	P11	P10	Read impossible	
R6	Bank 2	P27	P26	P25	P24	P23	P22	P21	P20	Read impossible	
R7	Bank 3	P37	P36	P35	P34	P33	P32	P31	P30	Read impossible	

CONNECTOR PINOUTS

1. POWER SUPPLY CONNECTOR (P8)

PIN	DESCRIPTION
1	POWER GOOD
2	+5V DC
3	+12V DC
4	-12V DC
5	GROUND
6	GROUND
7	GROUND
8	GROUND
9	-5V DC
10	+5V DC
11	+5V DC
12	+5V DC

2. SPEAKER CONNECTOR (J19)

PIN	DESCRIPTION
1	SPEAKER DATA OUT
2	KEY
3	GROUND
4	+5V DC

3. **KEYBOARD SWITCH
& LED CONNECTOR (J20)**

PIN	DESCRIPTION
1	LED POWER
2	KEY
3	GROUND
4	KEYBOARD INHIBITOR
5	GROUND

4. **KEYBOARD CONNECTOR (J22)**

PIN	DESCRIPTION
1	KEYBOARD CLOCK
2	KEYBOARD DATA
3	SPARE
4	KEYBOARD GROUND
5	+5V DC

5. RESET CONNECTOR (JP6)

PIN	DESCRIPTION
1	RESET IN
2	GROUND

6. HIGH SPEED LED CONNECTOR(TUBLED)

PIN	DESCRIPTION
1	+ ANODE
2	- CATHODE

NOTES:

- 1) XTAL SET 20MHz = LED ON**
- 2) XTAL SET 12MHz = LED OFF**

I/O CHANNELS

The following figures show the location and the numbering of the I/O channel connectors. These connectors consist of eight pin and six 36-pin edge connector sockets.

REAR PANEL

-MEM CS16	ID1	C1I	SBHE
-I/O CS16	ID2	C2I	LA23
IR 10	ID3	C3I	LA22
IR 11	ID4	C4I	LA21
IR 12	ID5	C5I	LA20
IR 15	ID6	C6I	LA19
IR 14	ID7	C7I	LA18
-DACK 0	ID8	C8I	LA17
DRA 0	ID9	C9I	MEMR
-DACK 5	ID10	C10I	MEMW
DRQ 5	ID11	C11I	SD08
-DACK 6	ID12	C12I	SD09
DRQ 6	ID13	C13I	SD10
-DACK 7	ID14	C14I	SD11
DRQ 7	ID15	C15I	SD12
+5V	ID16	C16I	SD13
-MASTER	ID17	C17I	SD14
GND	ID18	C18I	SD15

I/O CHANNEL PIN NUMBERING

REAR PANEL

GND	IB1	A1I	-I/O CH CK
RESET DRV	IB2	A2I	SD7
+5V	IB3	A3I	SD6
IR9	IB4	A4I	SD5
-5V	IB5	A5I	SD4
DRQ	IB6	A6I	SD3
-12V	IB7	A7I	SD2
OWS	IB8	A8I	SD1
+12V	IB9	A9I	SD0
GND	IB10	A10I	-I/O CH RDY
-S MEMW	IB11	A11I	AEN
-S MEMR	IB12	A12I	SA19
-IOW	IB13	A13I	SA18
-IOR	IB14	A14I	SA17
-DACK 3	IB15	A15I	SA16
DRQ 3	IB16	A16I	SA15
-DACK 1	IB17	A17I	SA14
DRQ 1	IB18	A18I	SA13
-REFRESH	IB19	A19I	SA12
SYSCLK	IB20	A20I	SA11
IR 7	IB21	A21I	SA10
IR 6	IB22	A22I	SA9
IR 5	IB23	A23I	SA8
IR 4	IB24	A24I	SA7
IR 3	IB25	A25I	SA6
-DACK 2	IB26	A26I	SA5
T/C	IB27	A27I	SA4
BALE	IB28	A28I	SA3
+5V	IB29	A29I	SA2
OSC	IB30	A30I	SA1
GND	IB31	A31I	SA0

I/O CHANNEL PIN NUMBERING

SYSTEM BLOCK DIAGRAM

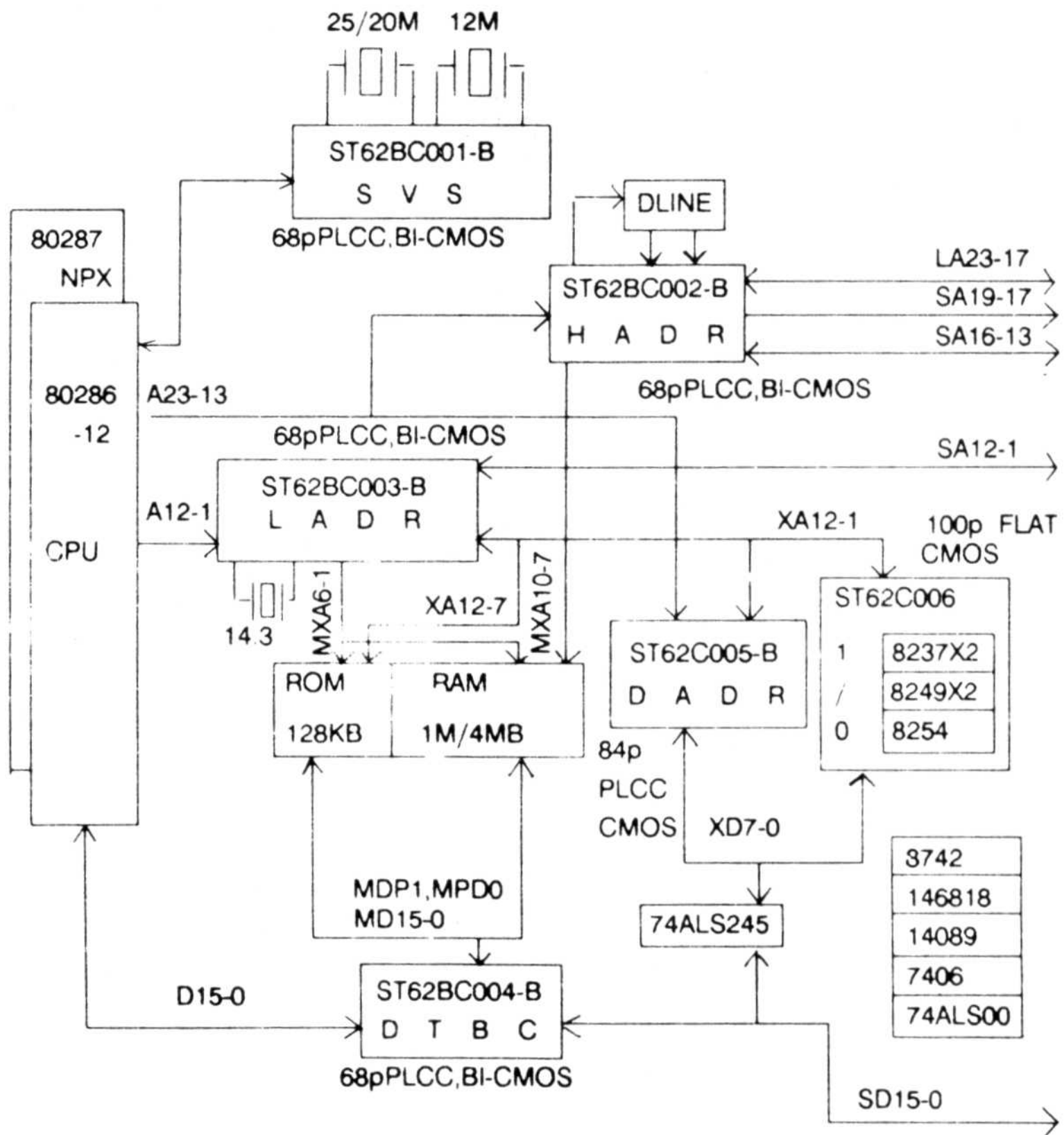

MEMORY ADDRESS

DRAM

NO	DIP Switch setting			Memory type		Memory size	Memory Location
	S6	S7	S8	BANK1	BANK0		
0	ON	ON	ON	NONE	256Kbits	512KB	0-7FFFF
1	ON	ON	OFF	64Kbits	256Kbits	640KB	0-9FFFF
2	ON	OFF	ON	256Kbits	256Kbits	640KB + 384KB	0-9FFFF 100000-15FFFF
3	ON	OFF	OFF	256Kbits	256Kbits	640KB + EMS (16KB X 24pages)	0-9FFFF
4	OFF	ON	ON	NONE	1Mbits	640KB + 1408KB	0-9FFFF 100000-25FFFF
5	OFF	ON	OFF	NONE	1Mbits	640KB + EMS (16KB X 88pages)	0-9FFFF
6	OFF	OFF	ON	1Mbits	1Mbits	640KB + 3456KB	0-9FFFF 100000-45FFFF
7	OFF	OFF	OFF	1Mbits	1Mbits	640KB + EMS (16KB X 216pages)	0-9FFFF

